

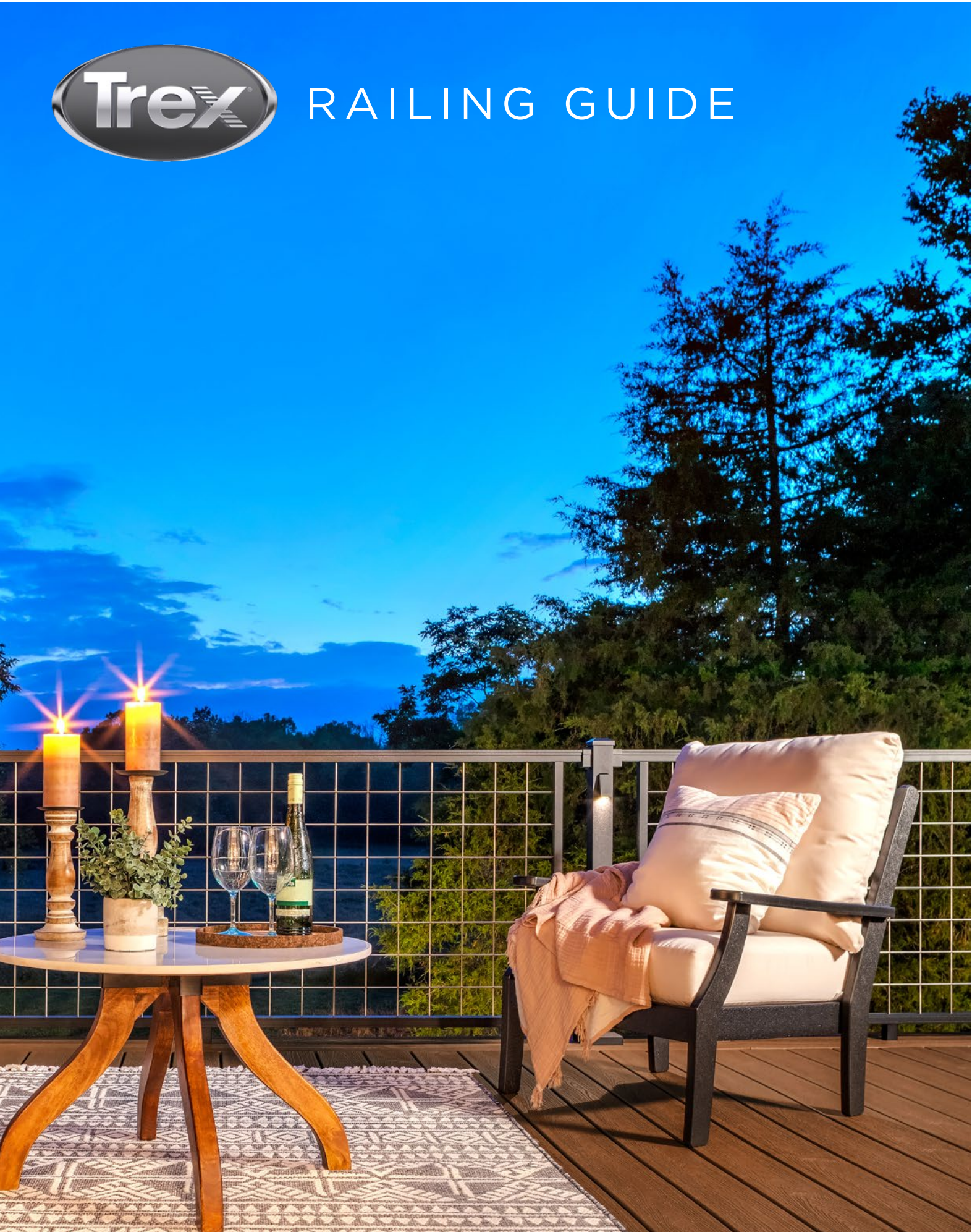

# RAILING GUIDE





# TREX RAILING

*What all the best decks are wearing*

- Introduction \_\_\_\_\_ 4
- Comparison Chart \_\_\_\_\_ 14
- Trex Signature® Railing \_\_\_\_\_ 16
  - Product Options \_\_\_\_\_ 20
- Trex Transcend® Railing \_\_\_\_\_ 26
  - Product Options \_\_\_\_\_ 30
- Trex Select® Railing \_\_\_\_\_ 36
  - Product Options \_\_\_\_\_ 38
- Trex Decking & Railing Duos \_\_\_\_\_ 40
- Railing Enhancements \_\_\_\_\_ 42
- Product SKUs
  - Trex Post Components \_\_\_\_\_ 46
    - Signature \_\_\_\_\_ 48
    - Transcend \_\_\_\_\_ 54
    - Select \_\_\_\_\_ 59
  - Trex® Outdoor Lighting™ \_\_\_\_\_ 60
  - Aluminum ADA Compliant Handrail \_\_\_\_\_ 62
  - Aluminum Gates \_\_\_\_\_ 63
- Warranties \_\_\_\_\_ 64
- Tools \_\_\_\_\_ 66



TREX SIGNATURE RAILING



TREX TRANSCEND RAILING

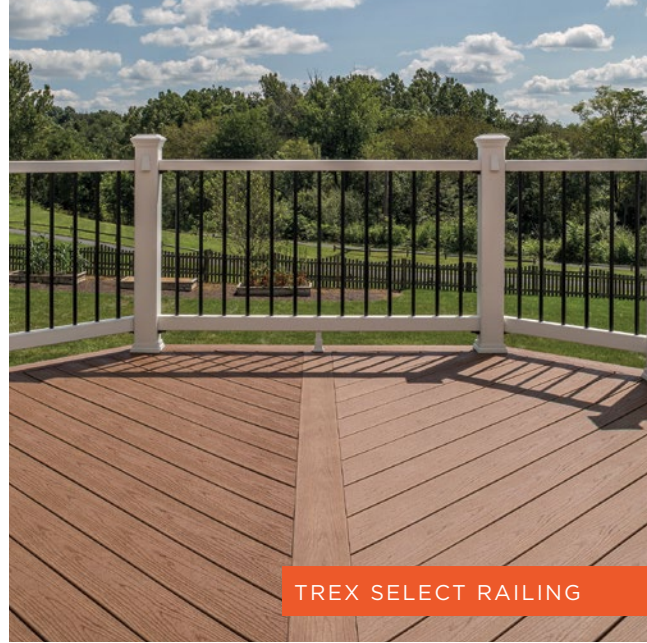

TREX SELECT RAILING



# Three lines, ENDLESS POSSIBILITIES

---

With railing options for all tastes and budgets, it's never been easier to make the Trex decision that's right for you™. Let these pages guide you through the selection process, whether railing is a major design feature of your project or the means to meeting building codes.



### FORGET SEASONAL UPKEEP

Our low-maintenance, high-performance railing needs no painting, sealing or staining.



### ELIMINATE THE GUESSWORK

Pre-designed railing kits in our most popular looks keep things simple.



### INNOVATE WITHOUT WASTE

All of our eco-friendly railing is made of a minimum of 40% recycled materials.



### ENJOY PEACE OF MIND

Our code-compliant railing lines are backed by a 25-Year Limited Residential Warranty.



Photo © 2018 Discovery or its subsidiaries and affiliates. All rights reserved.

**Trex**Signature®  
RAILING

EFFORTLESS STYLE, EXCEPTIONAL STRENGTH

**Trex**Transcend®  
RAILING

TIMELESS DESIGN YOU CAN TRUST—AND TAILOR

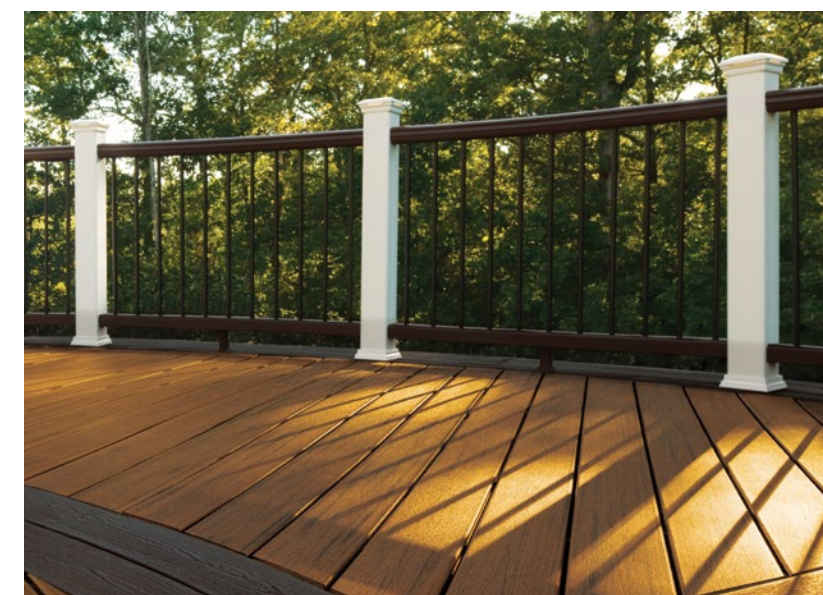

**Trex**Select®  
RAILING

THE SIMPLE CHOICE FOR YOUR BACKYARD





posts: Signature in BK  
rail kit: Signature Rod Rail in BKPL

# RAILING CONSIDERATIONS

1

## **THINK ABOUT STYLE**

Our railing lines provide a range of styles to suit any home. Does yours lean traditional, modern or somewhere in between?

2

## **CHOOSE MATERIALS**

The choice between an aluminum, composite and mixed materials look is a foundational design decision.

3

## **STAY WITHIN BUDGET**

Determine what you're willing to spend and plan accordingly. We have an option for every wallet.

4

## **CONSIDER COMPLEXITY**

Which will you prioritize for the project: more color and material options or an easier selection process?

5

## **ADD FEATURES & ENHANCEMENTS**

Complete your outdoor area with cocktail railing, lighting, handrails, gates and more.



ALUMINUM

Classic White  
WT

Bronze  
BZ

Charcoal Black  
BK

Platinum  
PL  
(rods only)

OTHER

Stainless Steel  
SS  
(mesh infill)

Glass  
(infill)



# TrexSignature®

RAILING

*EFFORTLESS STYLE, EXCEPTIONAL STRENGTH*

Imagine top-tier durability and the refined beauty of negative space. Our four contemporary Trex Signature options feature powder-coated aluminum rails that resist fading and corrosion, as well as unique infills to frame the view.





COMPOSITE

Classic White  
WT

Charcoal Black  
BK

Gravel Path  
GP

Rope Swing  
RS

Tree House  
TH

Vintage Lantern  
VL

ALUMINUM

Classic White  
WT

Bronze  
BZ

Charcoal Black  
BK



# Trex Transcend®

## RAILING

*TIMELESS DESIGN YOU CAN TRUST—AND TAILOR*

No other line offers the freedom to mix and match infill and rails like Trex Transcend. As strong and sturdy as its namesake decking, Transcend puts every color combination within reach. Get style-specific or eliminate the guesswork with pre-designed kits.

Photo © 2017 Discovery or its subsidiaries and affiliates. All rights reserved.

*posts: Trex Post Components in BK  
rails: Transcend Universal top/bottom in BK with cocktail rail  
infill: Glass panel*

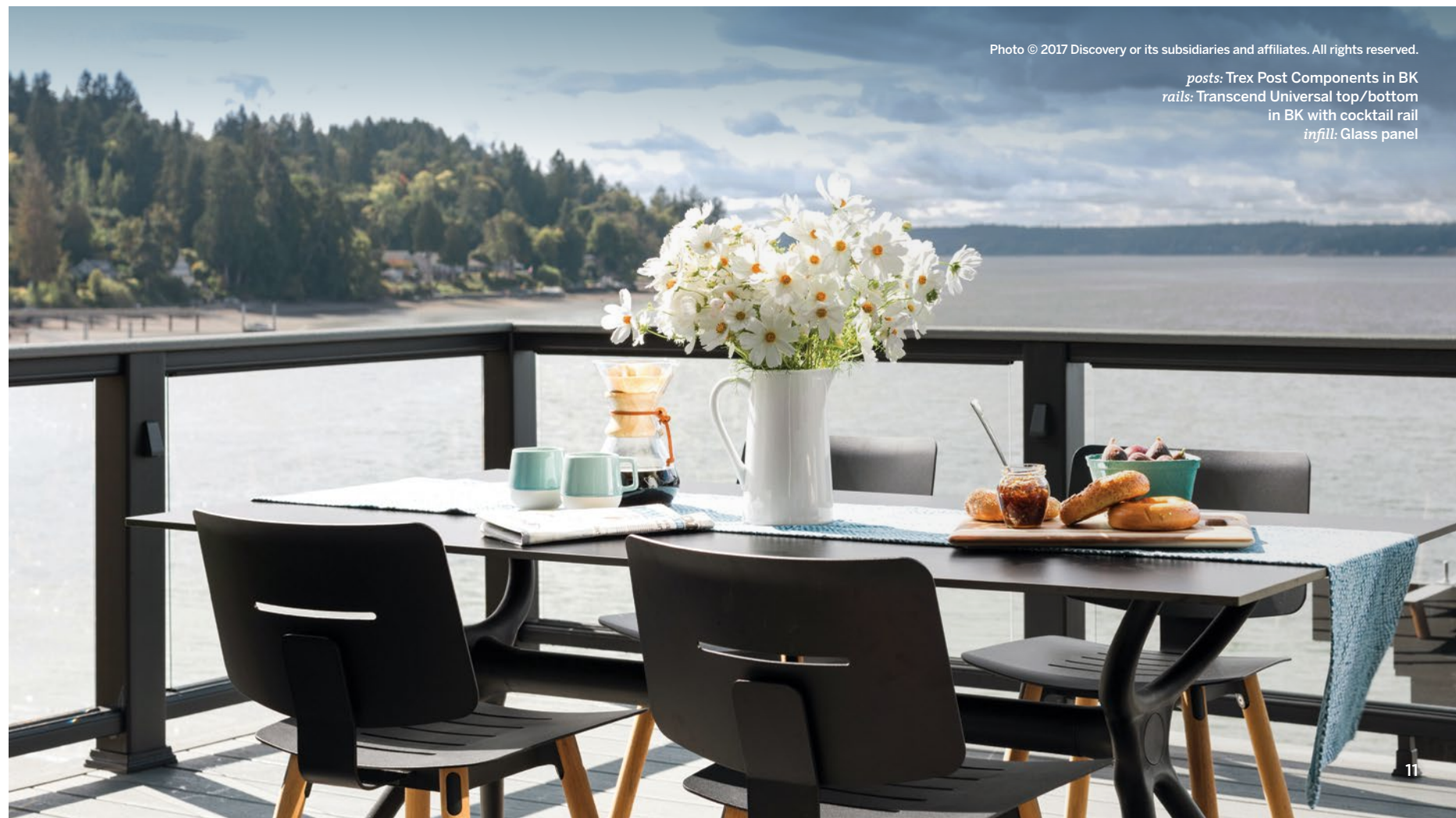



Classic White  
WT

ALUMINUM

Charcoal Black  
BK



posts: Trex Post Components in WT  
rail kit: Select in WT with round aluminum balusters in BK

# Trex Select®

RAILING

## THE SIMPLE CHOICE FOR YOUR BACKYARD

Why overthink what works? Crisp, safe and effective, Trex Select railing streamlines the design process by combining composite rails in Classic White and round aluminum balusters in Charcoal Black.



posts: Trex Post Components in WT  
rail kit: Select in WT with round aluminum balusters in BK with cocktail rail





**Trex Signature**  
RAILING



**Trex Transcend**  
RAILING

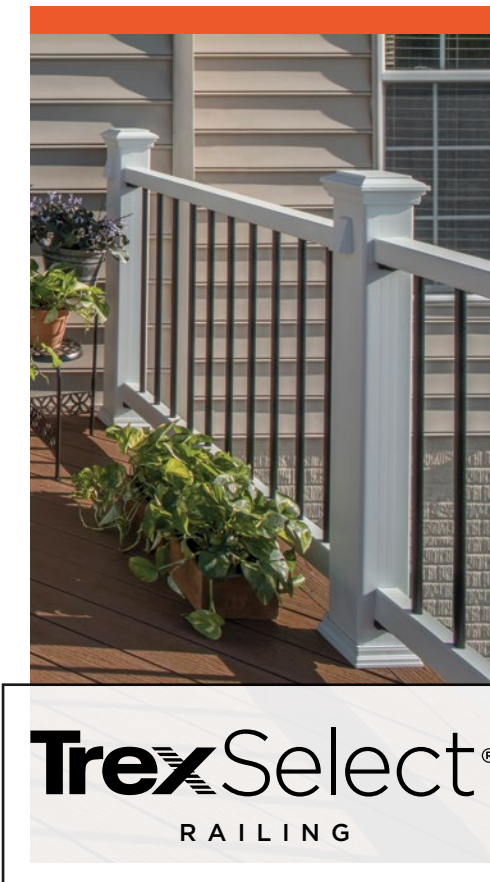

**Trex Select**  
RAILING

	ALUMINUM RAILING	ROD RAIL	MESH RAILING	GLASS RAILING
	RAIL KITS			
POSTS & RAILS	Aluminum <sup>1</sup>			
INFILLS	Square aluminum balusters OR Round aluminum balusters	Aluminum rods	Mesh panel	Glass panel <sup>2</sup>
AVAILABLE COLORS	<b>3</b>	<b>3</b>	<b>2</b>	<b>2</b>
CURVABLE <sup>3</sup>	✓			
COCKTAIL RAIL <sup>4</sup>	✓	✓	✓	
COST	<b>\$\$-\$\$\$\$</b>			
STYLE	<b>MODERN</b>			

	RAIL KITS	CUSTOM ROUTE
	Composite	
	Square composite balusters OR Round aluminum balusters	
	Composite: <b>3</b> Aluminum: <b>1</b>	Composite: <b>6</b> Aluminum: <b>3</b>
	✓	✓
	✓	✓
	<b>\$\$-\$\$\$</b>	
	<b>TRADITIONAL</b>	

	RAIL KIT
	Composite
	Round aluminum balusters
	<b>1</b>
	✓
	<b>\$</b>
	<b>STANDARD</b>

<sup>1</sup> Rails also compatible with composite Trex Post Components.

<sup>2</sup> To complete your rail section, visit [glass.trex.com](http://glass.trex.com)

<sup>3</sup> See [trex.com](http://trex.com) for more information on curving Trex Signature Railing.

<sup>4</sup> A cocktail rail uses Trex Transcend or Select deck boards to turn your railing into an additional surface for drinks and more. All deck boards sold separately.





**Trex**Signature®  
RAILING



# Look A: Aluminum Posts

Keep it consistent with aluminum posts and rails, available in three powder-coated colors.



# Look B: Composite Posts

Create a mixed materials look with Trex Post Components and aluminum rails. The addition of composite allows for even more color combinations.

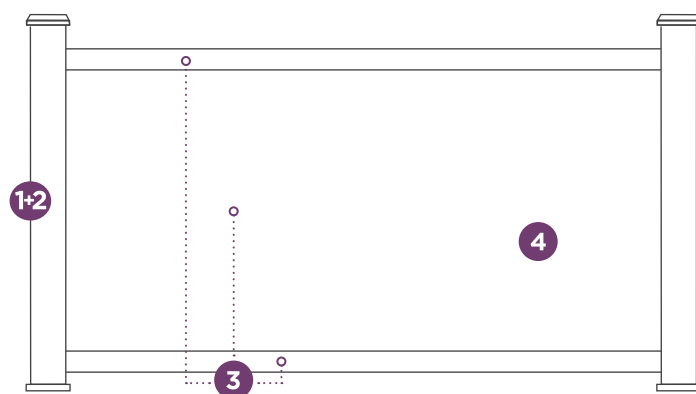

- 1+2 ALUMINUM POST + CAP & SKIRT**
- 3 RAIL KIT: TOP RAIL, BOTTOM RAIL, INFILL**
- 4 MESH OR GLASS INFILL PANEL**

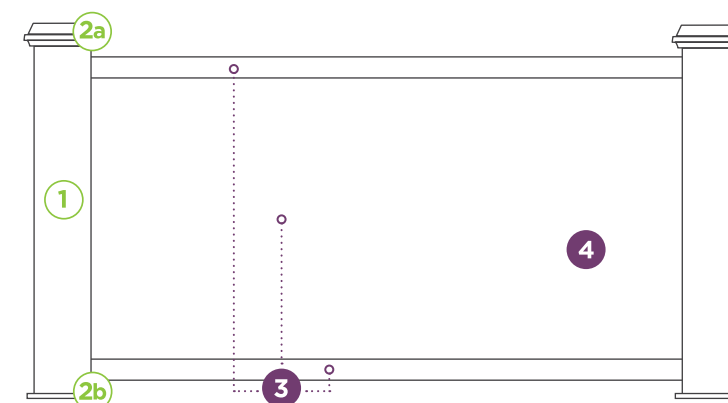

- 1 POST SLEEVE**
- 2a POST SLEEVE CAP**
- 2b POST SLEEVE SKIRT**
- 3 RAIL KIT: TOP RAIL, BOTTOM RAIL, INFILL**
- 4 MESH OR GLASS INFILL PANEL**

## ALUMINUM RAILING

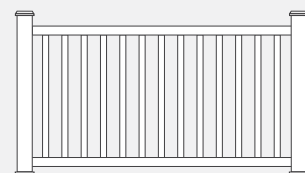

COLORS:

1+2 3

## ROD RAIL

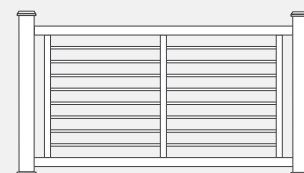

COLOR COMBINATIONS:

BZ	BK	BK
PL	PL	BK

First color denotes rails; second color denotes infill.

1+2 3

## ALUMINUM RAILING

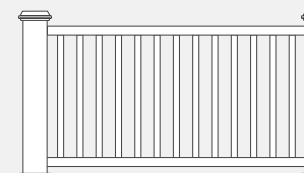

COLORS:

1 2a 2b 3

## ROD RAIL

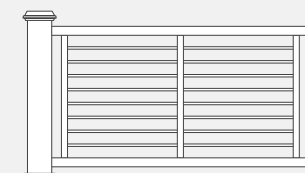

COLOR COMBINATIONS:

BZ	BK	BK
PL	PL	BK

First color denotes rails; second color denotes infill.

1 2a 2b 3

## MESH RAILING

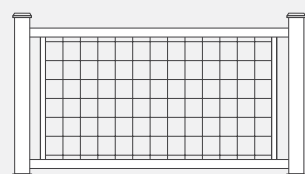

COLORS:

Mesh is 316 mill-finish stainless steel.

1+2 3 4

## GLASS RAILING

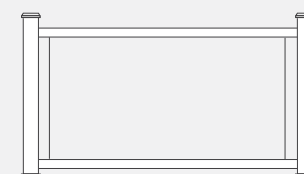

COLORS:

1+2 3 4

## MESH RAILING

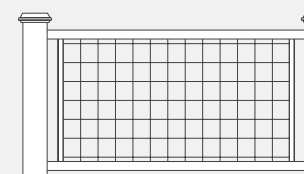

COLORS:

Mesh is 316 mill-finish stainless steel.

1 2a 2b 3 4

## GLASS RAILING

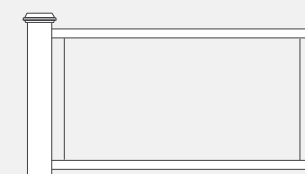

COLORS:

1 2a 2b 3 4



# Product Options

## LOOK A

Continue with Step 1+2 to pick your aluminum posts.

## LOOK B

Jump to Steps 1, 2a and 2b on page 22 to pick your composite posts.

### STEP 1+2: PICK AN ALUMINUM POST STYLE

1+2

#### ALUMINUM POST

Use for a traditional aluminum post look.



**Heights**  
37", 43"  
53"

**Applications**  
Horizontal  
Stair



1+2

#### ALUMINUM CROSSOVER POST

Use for a continuously graspable top rail.



**Heights**  
36", 42"

**Applications**  
Horizontal, Stair\*



\*Stair crossover applications can only be achieved with the use of a swivel crossover bracket. See page 53 (item# XX25RCSWSCBKAL).

1+2

#### ALUMINUM JOIST MOUNT POST

Use with steel deck framing or wood framing.



**Heights**  
63"

**Applications**  
Horizontal



1+2

#### ALUMINUM POST WITH PREMOUNTED BRACKETS

Use for simple and quick post applications.



**Heights**  
37", 43"

**Applications**  
Horizontal

**Brackets**  
Line, End, Corner



Simplify Step 3 by choosing Assembled Square Baluster Panels, shown on page 23.



**STEPS 1, 2A, 2B: PICK A COMPOSITE POST STYLE**

1

**POST SLEEVE**

Each 4" x 4" and 6" x 6" post sleeve fits over a 4" x 4" pressure treated post or equivalent post mount. 6" x 6" width only available in Classic White.



**Heights**  
39", 108"

**Widths**  
4" x 4", 6" x 6"



2a

**POST SLEEVE CAP**

6" x 6" width only available in Classic White.



**Widths**  
4" x 4", 6" x 6"



*Opt for a post cap light variation. Details on page 60.*

2b

**POST SLEEVE SKIRT**

6" x 6" width only available in Classic White.



**Widths**  
4" x 4", 6" x 6"



**STEP 3: GO WITH A RAIL KIT**

3

**ALUMINUM RAIL & SQUARE BALUSTER KIT**



**Heights**  
36", 42"

**Lengths**  
6', 8'

**Applications**  
Horizontal, Stair



3

**ALUMINUM RAIL & ROUND BALUSTER KIT**



**Heights**  
36", 42"

**Lengths**  
6', 8'

**Applications**  
Horizontal, Stair



3

**ASSEMBLED SQUARE BALUSTER PANEL**

Use for simple and quick rail applications. Brackets sold separately.



**Heights**  
36", 42"

**Lengths**  
4', 6', 8'

**Applications**  
Horizontal





**3** ROD RAIL KIT

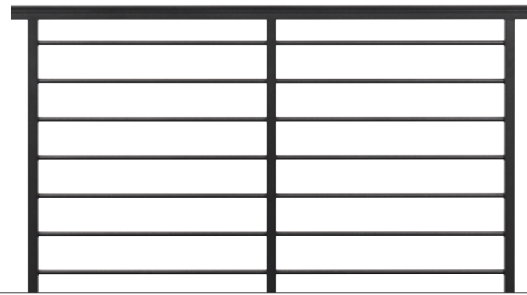

Heights	Lengths	Applications
36", 42"	6', 8'	Horizontal, Stair



First color denotes rails; second color denotes infill.

**3** MESH RAIL KIT

Mesh infill sold separately. Continue to Step 4 to complete your build.

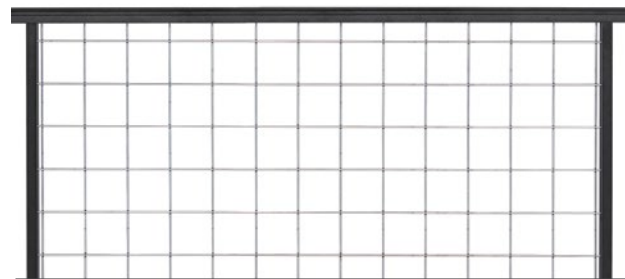

Heights	Lengths	Applications
36", 42"	6', 8'	Horizontal, Stair



**3** GLASS RAIL KIT

Glass infill sold separately. Continue to Step 4 to complete your build.



Lengths	Applications
6'	Horizontal



**STEP 4: MESH & GLASS INFILL PANELS**

**4** MESH INFILL PANEL

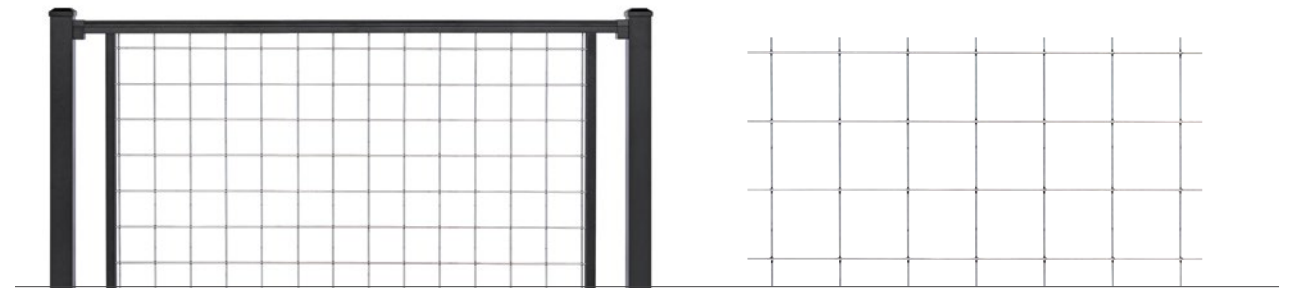

Heights	Lengths	Applications
36", 42"	6', 8'	Horizontal, Stair



**4** GLASS INFILL PANEL

Visit [glass.trex.com](http://glass.trex.com) to order custom glass panels to complete your build.



**Additional Specs**

36" (914 mm) high rail: 1/4" x 32-5/16" x 67" max. (6 mm x 821 mm x 1702 mm)  
 42" (1067 mm) high rail: 1/4" x 38-5/16" x 67" max. (6 mm x 973 mm x 1702 mm)

*Want an additional surface for drinks, planters and more?  
 Add a cocktail rail using Transcend or Select deck boards.  
 For installation, see Cocktail Rail Bracket on page 52.*

Not compatible with Signature Glass railing.





**Trex** Transcend®  
RAILING

## Traditional style made simple WITH RAIL KITS

A Transcend kit includes composite top and bottom rails and your choice of square composite or round aluminum balusters. That means:

-   
*Fewer steps in your selection and ordering processes*
-   
*Railing componentry all in one box\**
-   
*Pre-designed in our most popular looks*

**KIT 1:**  
RAIL & SQUARE  
COMPOSITE BALUSTER



**KIT 2:**  
RAIL & ROUND  
ALUMINUM BALUSTER



**KIT 3:**  
COCKTAIL RAIL & ROUND  
ALUMINUM BALUSTER



A cocktail rail kit allows for a Transcend or Select deck board\*\* to be installed on top of a Universal top/bottom rail, creating the perfect flat surface for beverages, planters and more.

Cocktail rail kits only available with rails in WT with round aluminum balusters in BK.

\*Post sleeve, cap and skirt sold separately.  
\*\*All deck boards sold separately.



# Look A: Rail Kit

Available in our most popular composite hues, a Transcend kit simplifies decision making.

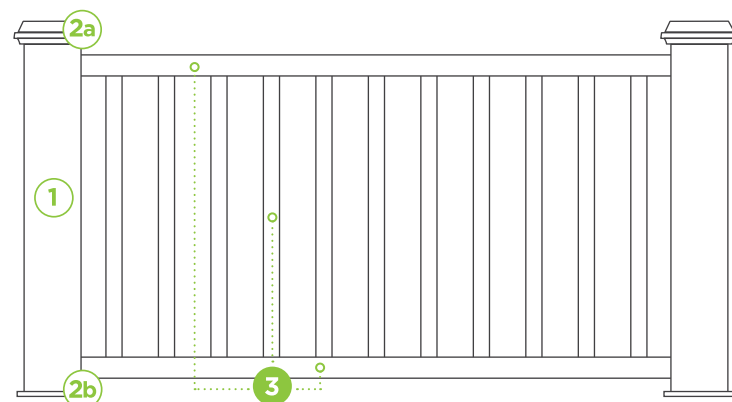

- 1 POST SLEEVE
- 2a POST SLEEVE CAP
- 2b POST SLEEVE SKIRT
- 3 RAIL KIT: TOP RAIL, BOTTOM RAIL, INFILL

## 3 RAIL & BALUSTER KIT

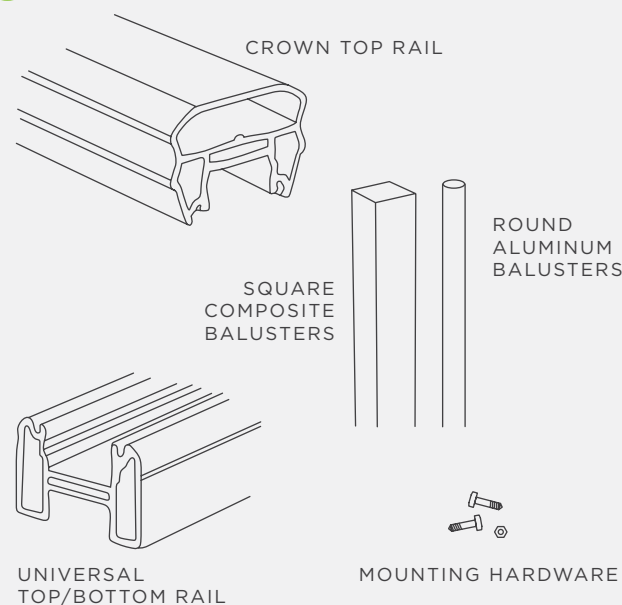

RAIL & BALUSTER KIT COLORS:



## 3 COCKTAIL RAIL & BALUSTER KIT

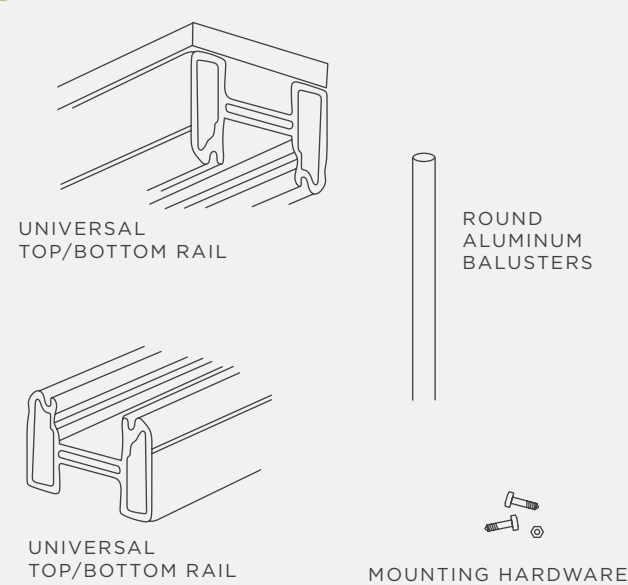

COCKTAIL RAIL & BALUSTER KIT COLORS:



# Look B: Custom Build

To choose from our full suite of colors and additional baluster options, go custom.

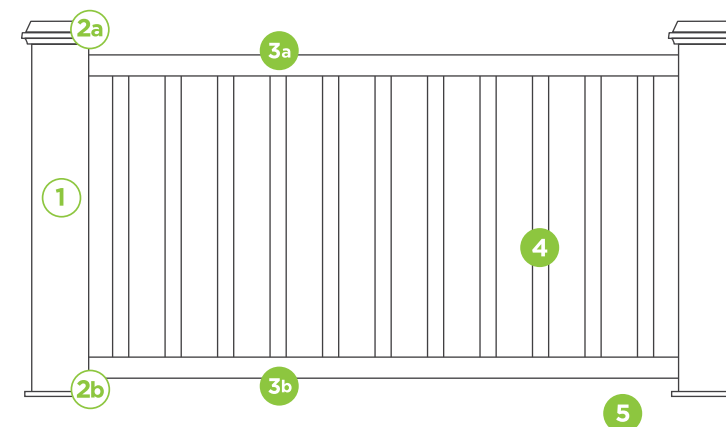

- 1 POST SLEEVE
- 2a POST SLEEVE CAP
- 2b POST SLEEVE SKIRT
- 3a TOP RAIL
- 3b BOTTOM RAIL
- 4 INFILL
- 5 ACCESSORY INFILL KIT

## 3a

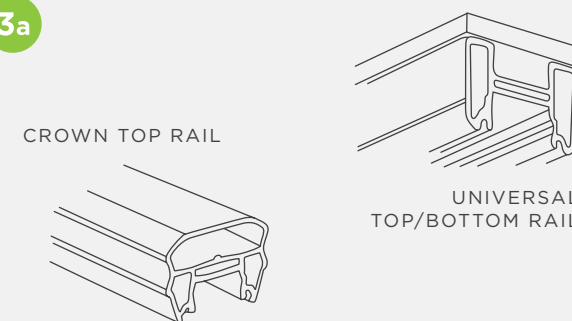

## 3b

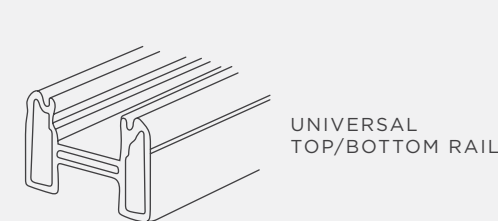

## 4

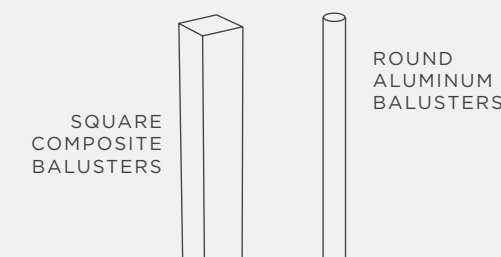

## 5

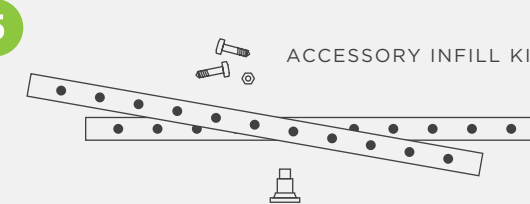

CUSTOM COLORS:

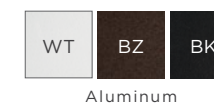



# Product Options

## STEPS 1, 2A, 2B: PICK A POST STYLE

1

### POST SLEEVE

Each 4" x 4" and 6" x 6" post sleeve fits over a 4" x 4" pressure treated post or equivalent post mount. 6" x 6" width only available in Classic White.



**Heights**  
39", 108"

**Widths**  
4" x 4", 6" x 6"



2a

### POST SLEEVE CAP

6" x 6" width only available in Classic White.



**Widths**  
4" x 4", 6" x 6"



*Opt for a post cap light variation. Details on page 60.*

2b

### POST SLEEVE SKIRT

6" x 6" width only available in Classic White.



**Widths**  
4" x 4", 6" x 6"



### LOOK A

Simply continue with Step 3 to complete your kit look.

### LOOK B

Jump to Steps 3a and 3b on the next page to build your custom look.

## STEP 3: GO WITH A RAIL KIT

3

### RAIL & SQUARE COMPOSITE BALUSTER KIT

Use for simplified, pre-designed rail applications.



**Heights**  
36", 42"

**Lengths**  
6', 8'  
(67.5", 91.5")

**Applications**  
Horizontal, Stair



3

### RAIL & ROUND ALUMINUM BALUSTER KIT

Use for simplified, pre-designed rail applications.



**Heights**  
36", 42"

**Lengths**  
6', 8'  
(67.5", 91.5")

**Applications**  
Horizontal, Stair



3

### COCKTAIL RAIL & ROUND ALUMINUM BALUSTER KIT

Use for simplified, pre-designed rail applications. Only Trex Transcend and Select deck boards can be used for cocktail rail applications. Boards sold separately.



**Heights**  
36"

**Lengths**  
6', 8'  
(67.5", 91.5")

**Applications**  
Horizontal, Stair





**STEP 3A: PICK A TOP RAIL**

**3a CROWN TOP RAIL**



*Lengths*  
6', 8'  
(67.5", 91.5")



**3a UNIVERSAL TOP/BOTTOM RAIL**

Use for cocktail rail applications.



*Lengths*  
6', 8'  
(67.5", 91.5")



**STEP 3B: PICK A BOTTOM RAIL**

**3b UNIVERSAL TOP/BOTTOM RAIL**



*Lengths*  
6', 8'  
(67.5", 91.5")



**STEP 4: CHOOSE AN INFILL**

**4 SQUARE COMPOSITE BALUSTERS**

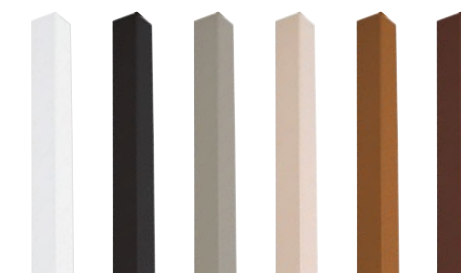

*Heights*  
36", 42"



**4 ROUND ALUMINUM BALUSTERS**



*Heights*  
36", 42"



**4 GLASS INFILL PANEL**

Visit [glass.trex.com](http://glass.trex.com) to order custom glass panels to complete your build.

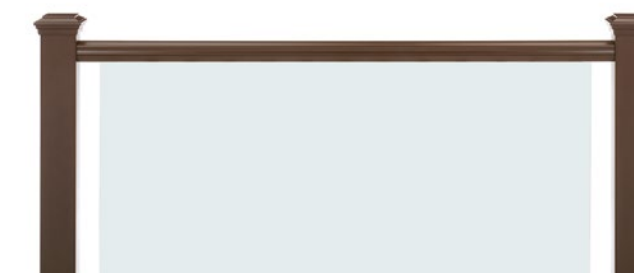

*Additional Specs*

36" (914 mm) high rail: 1/4" x 32-5/16" x 67" max. (6 mm x 821 mm x 1702 mm)  
42" (1067 mm) high rail: 1/4" x 38-5/16" x 67" max. (6 mm x 973 mm x 1702 mm)



**STEP 5: SELECT AN ACCESSORY INFILL KIT**

5

**SQUARE COMPOSITE BALUSTER INFILL KIT**

Use this hardware to assemble a railing section consisting of square composite balusters.



*Lengths*  
6', 8'

*Applications*  
Horizontal, Stair



5

**GLASS PANEL INFILL KIT**

Use this hardware to assemble a railing section with a glass infill.

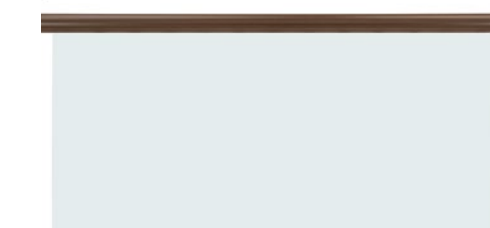

*Lengths*  
6'



5

**ROUND ALUMINUM BALUSTER INFILL KIT**

Use this hardware to assemble a railing section consisting of round aluminum balusters.



*Lengths*  
6', 8'

*Applications*  
Horizontal, Stair







**Trex**Select®  
RAILING

## The Standard Look

Trex Select rails and balusters come in one neutral colorway—which means choosing your Trex Post Components is the only choice you'll have to make.

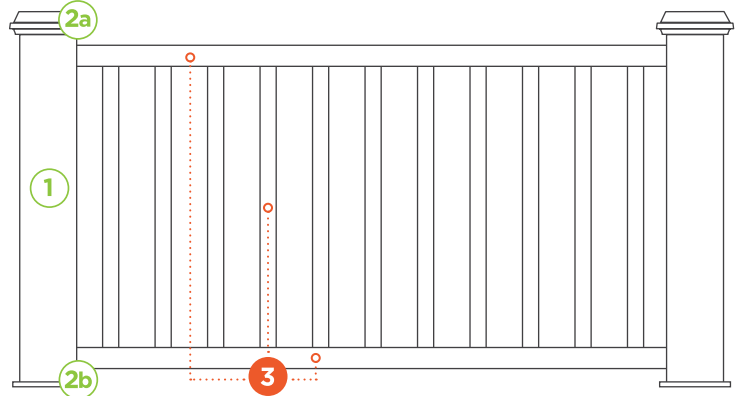

- 1 POST SLEEVE
- 2a POST SLEEVE CAP
- 2b POST SLEEVE SKIRT
- 3 RAIL KIT: TOP RAIL, BOTTOM RAIL, INFILL

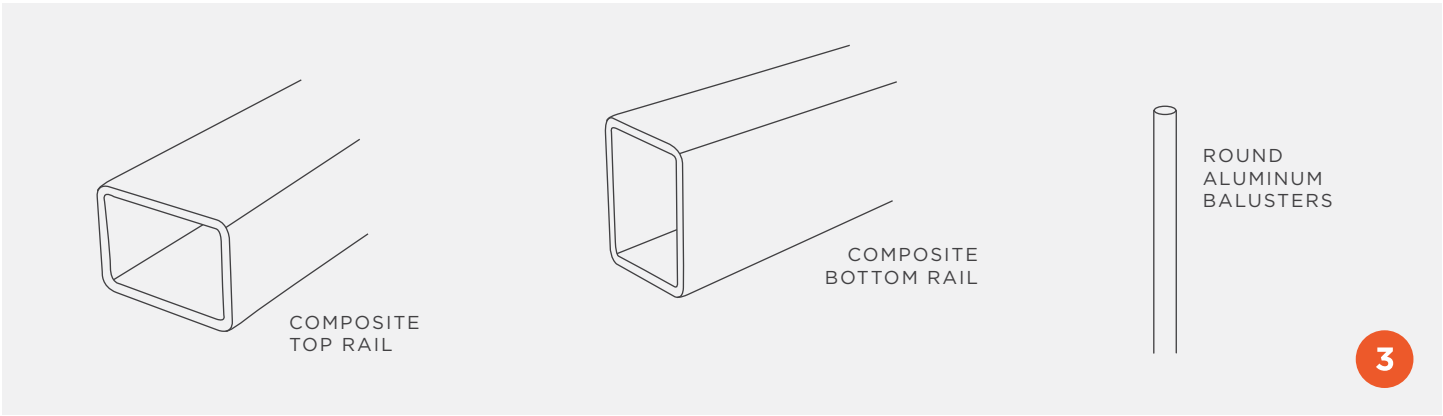

KIT COLORS: WT BK  
Composite Aluminum



# Product Options

## STEPS 1, 2A, 2B: PICK A POST STYLE

1

### POST SLEEVE

Each 4" x 4" and 6" x 6" post sleeve fits over a 4" x 4" pressure treated post or equivalent post mount. 6" x 6" width only available in Classic White.



**Heights**  
39", 108"

**Widths**  
4" x 4", 6" x 6"



2a

### POST SLEEVE CAP

6" x 6" width only available in Classic White.



**Widths**  
4" x 4", 6" x 6"



*Opt for a post cap light variation. Details on page 60.*

2b

### POST SLEEVE SKIRT

6" x 6" width only available in Classic White.



**Widths**  
4" x 4", 6" x 6"



3

### RAIL & ROUND ALUMINUM BALUSTER KIT

Use for simplified, pre-designed rail applications.



**Heights**  
36", 42"

**Lengths**  
6', 8'  
(67.5", 91.5")

**Applications**  
Horizontal, Stair

WT

*Want an additional surface for drinks, planters and more? Add a cocktail rail using Transcend or Select deck boards.*



*The ultimate railing shortcut*

# TREX DECKING & RAILING DUOS

Trex created Decking & Railing Duos to simplify your planning process. Our design team perfectly matched **three unique railing looks** to each of our composite board colors. The result?

More than 60 unique ensembles, all accompanied with a thorough list of materials that makes ordering easy.

Take a look at the three options we curated for Transcend Spiced Rum decking.

Visit [trex.com/duos](https://www.trex.com/duos) to see each and every combination.

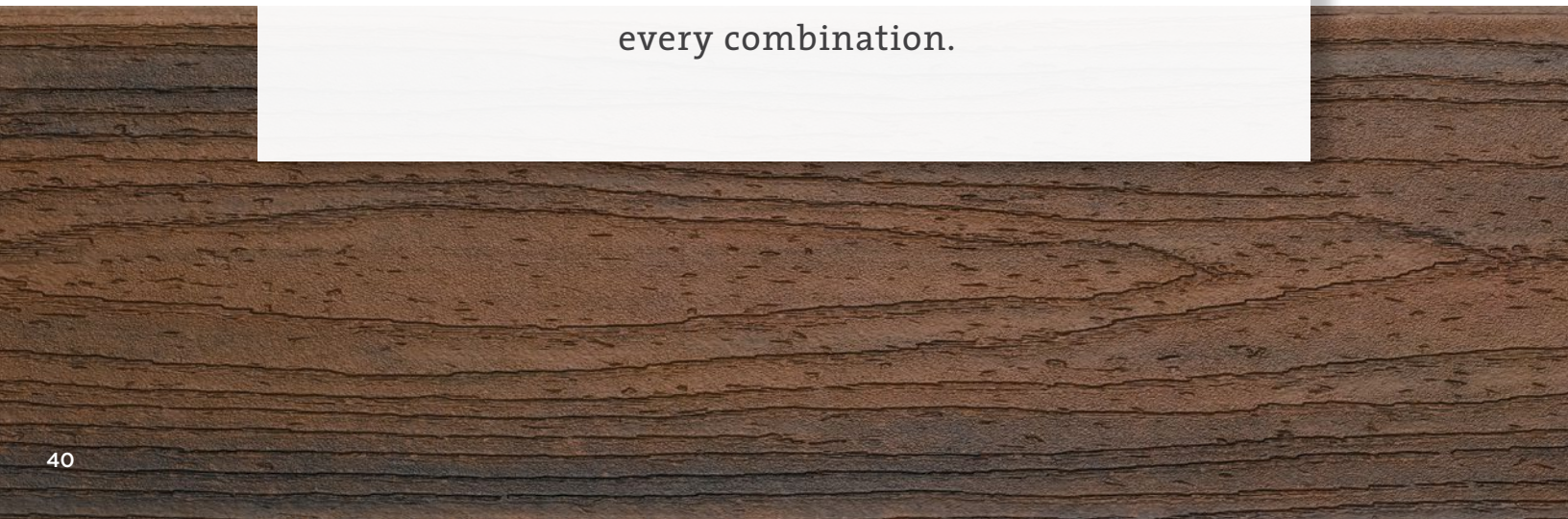



# TREX RAILING

## *enhancements*

---

Whether you want to brighten your outdoor space or ensure it's accessible, a few add-ons can truly elevate a deck. Our enhancements are just as durable and design-minded as our railing.



---

OUTDOOR LIGHTING

---

---

ADA HANDRAIL

---

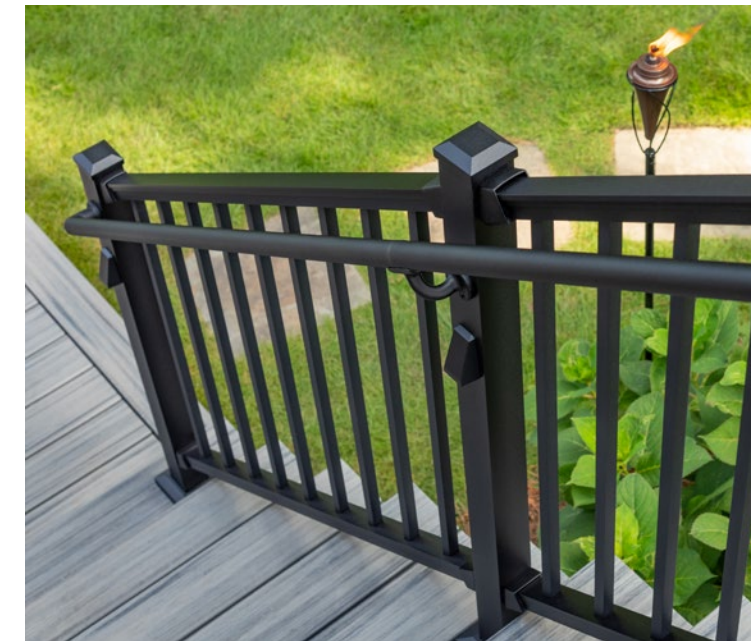

---

ALUMINUM GATES

---







## ALUMINUM ADA-COMPLIANT HANDRAIL

### *STRENGTH, DURABILITY & ACCESSIBILITY*

Compatible with every Trex railing option, our sturdy aluminum handrail features a durable, powder-coated finish that resists fading and corrosion.

Find product specifications on page 62.



## OUTDOOR LIGHTING

### *HOW SPACES GO FROM INVISIBLE TO INVITING*

Our soft white, energy-efficient LED lighting includes post cap lights, recessed deck lights, stair risers and more, all backed by a limited warranty.

Discover lighting options compatible with every Trex railing line on page 60.



## ALUMINUM GATES

### *ENTER SUPERIOR SECURITY*

Our powder-coated aluminum gates add secure entrances to any outdoor space and can be easily customized up to 48" wide.

See color and baluster options on page 63.



# TREX POST COMPONENTS

## 1 POST SLEEVE

COMPONENT	DIMENSIONS	ITEM #	COLORS
<b>Post Sleeve</b> Includes 1 post sleeve. 	4" x 4" x 39" Composite Post Sleeve <i>Actual external dimensions: 4.45 in x 4.45 in x 40 in (113 mm x 113 mm x 101 cm)</i>	XX040439APS	WT BK GP RS TH VL
	4" x 4" x 108" Composite Post Sleeve <i>Actual external dimensions: 4.45 in x 4.45 in x 108 in (113 mm x 113 mm x 274 cm)</i>	XX0404108APS	
	6" x 6" x 39" Composite Post Sleeve <i>Actual external dimensions: 5.5 in x 5.5 in x 39 in (139 mm x 139 mm x 990 mm)</i>	WT060639APS	WT
	6" x 6" x 108" Composite Post Sleeve <i>Actual external dimensions: 5.5 in x 5.5 in x 108 in (139 mm x 139 mm x 274 cm)</i>	WT0606108APS	

## 2a POST SLEEVE CAP

COMPONENT	DIMENSIONS	ITEM #	COLORS
<b>Post Sleeve Cap</b> Includes 1 post sleeve cap.  Also available with LED lighting. See page 60. 	Flat 4" x 4" Composite Post Sleeve Cap <i>Actual internal dimensions: 4.55 in x 4.55 in (115 mm x 115 mm)</i>	PXXSQCAP4X4	WT BK GP RS TH VL
	Flat 6" x 6" Composite Post Sleeve Cap <i>Actual internal dimensions: 5.55 in x 5.55 in (140 mm x 140 mm)</i>	PWTSQCAP6X6	

## 2b POST SLEEVE SKIRT



COMPONENT	DIMENSIONS	ITEM #	COLORS
<b>Post Sleeve Skirt</b> Includes 1 post sleeve skirt. 	4" x 4" Composite Post Sleeve Skirt <i>Actual internal dimensions: 4.55 in x 4.55 in (115 mm x 115 mm)</i>	PXXSKIRT4X4	WT BK GP RS TH VL
	6" x 6" Composite Post Sleeve Skirt <i>Actual internal dimensions: 5.55 in x 5.55 in (140 mm x 140 mm)</i>	PWTSKIRT6X6	

XX=COLOR PREFIX

WT Classic White BK Charcoal Black GP Gravel Path RS Rope Swing TH Tree House VL Vintage Lantern

# TREX POST COMPONENTS

## ACCESSORIES

COMPONENT	DESCRIPTION	ITEM #	COLORS
<b>Aluminum Surface Mount Post</b> Includes 2 aluminum inserts with set screws and (1) 2.5" IRC-compliant aluminum post with base.  Mounting hardware sold separately. 	The Surface Mount Post is an alternative to a traditional wood post under the post sleeve. It is designed to be used on either decks or concrete surfaces.  <i>Actual external dimensions of insert: 3.75 in x 3.75 in x 7 in (95 mm x 95 mm x 177 mm)</i>	ALPOSTMOUNT36	n/a
		ALPOSTMOUNT42	
<b>Aluminum Surface Mount Post Hardware</b> Includes hardware for 2.5" Trex Signature surface mount posts, 1 aluminum backer plate, 4 HG carriage bolts and 4 HG washers and nuts. 	Designed specifically to connect the 36" or 42" Trex Surface Mount Post to a wood substructure.	ALPOSTHWDECK	n/a
<b>Aluminum Joist Mount Post</b> Includes (1) 63" aluminum post (cut-to-length), 2 aluminum inserts with set screws, (2) 1/2" HG bolts, washers and nuts, 1 bolt spacing template and (16) 316 SS screws. 	For use with all Trex railing heights and 4" x 4" and 6" x 6" Trex composite post sleeves.  <i>Actual external dimensions of insert: 3.75 in x 3.75 in x 7 in (95 mm x 95 mm x 177 mm)</i>	CPJMNTPOST63	n/a



Consult your local building department for project design and material specification review.



# TREX SIGNATURE RAILING

## 1+2 POSTS, CAPS & SKIRTS



COMPONENT	ORIENTATION	DIMENSIONS	ITEM #	COLORS
<b>Aluminum Post</b> Includes post, cap and skirt. 	Horizontal	2.5" x 2.5" x 37" Post	XXAL252537RCAP	WT BZ BK
		2.5" x 2.5" x 43" Post	XXAL252543RCAP	
	Stair	2.5" x 2.5" x 53" Post	XXAL252553RCAP	
<b>Aluminum Crossover Post</b> Includes post with premounted crossover bracket and skirt. 	Horizontal	2.5" x 2.5" x 36" Crossover Post	XXAL252536RCCP	WT BZ BK
		2.5" x 2.5" x 42" Crossover Post	XXAL252542RCCP	
<b>Aluminum Joist Mount Post</b> Includes post, cap, skirt, hardware and spacing template. For use with steel deck framing or wood framing. 	Horizontal	2.5" x 2.5" x 63" Joist Mount Post	XXJMNTPOST63	WT BZ BK
<b>Aluminum Post with Premounted Brackets</b> Includes post with premounted brackets, cap and skirt. 	Line	2.5" x 2.5" x 37" Post with Brackets	BKAL252537RCAPLINE	BK
		2.5" x 2.5" x 43" Post with Brackets	BKAL252543RCAPLINE	
	End	2.5" x 2.5" x 37" Post with Brackets	BKAL252537RCAPEND	
		2.5" x 2.5" x 43" Post with Brackets	BKAL252543RCAPEND	
	Corner	2.5" x 2.5" x 37" Post with Brackets	BKAL252537RCAPCNR	
		2.5" x 2.5" x 43" Post with Brackets	BKAL252543RCAPCNR	

Dimensions above are nominals. See below for actuals and metrics.

2.5 in x 2.5 in x 36 in (63 mm x 63 mm x 914 mm)	2.5 in x 2.5 in x 43 in (63 mm x 63 mm x 109 cm)
2.5 in x 2.5 in x 37 in (63 mm x 63 mm x 939 mm)	2.5 in x 2.5 in x 53 in (63 mm x 63 mm x 134 cm)
2.5 in x 2.5 in x 42 in (63 mm x 63 mm x 106 cm)	2.5 in x 2.5 in x 63 in (63 mm x 63 mm x 160 cm)

# TREX SIGNATURE RAILING

## 3 RAIL KITS

COMPONENT	ORIENTATION	DIMENSIONS	ITEM #	COLORS
<b>Aluminum Rail &amp; Square Baluster Kit</b> Includes top rail, bottom rail, balusters and mounting and support hardware. 	Horizontal	6' x 36" Rail & Baluster Kit	XXASO636HRK	WT BZ BK
		8' x 36" Rail & Baluster Kit	XXASO836HRK	
		6' x 42" Rail & Baluster Kit	XXASO642HRK	
		8' x 42" Rail & Baluster Kit	XXASO842HRK	
	Stair	6' x 36" Rail & Baluster Kit	XXASO636SRK	
		8' x 36" Rail & Baluster Kit	XXASO836SRK	
		6' x 42" Rail & Baluster Kit	XXASO642SRK	
		8' x 42" Rail & Baluster Kit	XXASO842SRK	
<b>Aluminum Rail &amp; Round Baluster Kit</b> Includes top rail, bottom rail, balusters and mounting and support hardware. 	Horizontal	6' x 36" Rail & Baluster Kit	BKARO636HRK	BK
		8' x 36" Rail & Baluster Kit	BKARO836HRK	
		6' x 42" Rail & Baluster Kit	BKARO642HRK	
		8' x 42" Rail & Baluster Kit	BKARO842HRK	
	Stair	6' x 36" Rail & Baluster Kit	BKARO636SRK	
		8' x 36" Rail & Baluster Kit	BKARO836SRK	
		6' x 42" Rail & Baluster Kit	BKARO642SRK	
		8' x 42" Rail & Baluster Kit	BKARO842SRK	
<b>Aluminum Assembled Square Baluster Panel</b> Includes a preassembled panel of railing with square balusters. Mounting hardware sold separately. 	Horizontal	4' x 36" Assembled Panel	BKASO436HRPNL	BK
		6' x 36" Assembled Panel	BKASO636HRPNL	
		8' x 36" Assembled Panel	BKASO836HRPNL	
		4' x 42" Assembled Panel	BKASO442HRPNL	
		6' x 42" Assembled Panel	BKASO642HRPNL	
		8' x 42" Assembled Panel	BKASO842HRPNL	

Dimensions above are nominals. See below for actuals and metrics.

4' x 36": 48 in x 36 in (122 cm x 914 mm)	6' x 36": 72 in x 36 in (182 cm x 914 mm)	8' x 36": 96 in x 36 in (243 cm x 914 mm)
4' x 42": 48 in x 42 in (122 cm x 106 cm)	6' x 42": 72 in x 42 in (182 cm x 106 cm)	8' x 42": 96 in x 42 in (243 cm x 106 cm)



# TREX SIGNATURE RAILING

## 3 RAIL KITS (continued)

COMPONENT	ORIENTATION	DIMENSIONS	ITEM #	COLORS
<b>Rod Rail Kit</b> Includes top rail, bottom rail, rods and mounting and support hardware.	Horizontal	6' x 36" Rod Rail Kit	XXXXROD0636HRK	BKPL BZPL BKBK  First color denotes rails; second color denotes infill.
		8' x 36" Rod Rail Kit	XXXXROD0836HRK	
		6' x 42" Rod Rail Kit	XXXXROD0642HRK	
		8' x 42" Rod Rail Kit	XXXXROD0842HRK	
	Stair	6' x 36" Rod Rail Kit	XXXXROD0636SRK	
		8' x 36" Rod Rail Kit	XXXXROD0836SRK	
		6' x 42" Rod Rail Kit	XXXXROD0642SRK	
		8' x 42" Rod Rail Kit	XXXXROD0842SRK	
<b>Mesh Rail Kit</b> Includes top rail, bottom rail, foot block, verticals, anti-rattle gaskets, hardware and bracket pack.  Mesh infill sold separately.	Horizontal	6' x 36" Mesh Railing Kit	XXA0636PNLHRK	BZ BK
		8' x 36" Mesh Railing Kit	XXA0836PNLHRK	
		6' x 42" Mesh Railing Kit	XXA0642PNLHRK	
		8' x 42" Mesh Railing Kit	XXA0842PNLHRK	
	Stair	6' x 36" Mesh Railing Kit	XXA0636PNLSRK	
		8' x 36" Mesh Railing Kit	XXA0836PNLSRK	
		6' x 42" Mesh Railing Kit	XXA0642PNLSRK	
		8' x 42" Mesh Railing Kit	XXA0842PNLSRK	
<b>Glass Rail Kit</b> Includes top rail, bottom rail, foot block, hardware and bracket pack.  To complete your rail section, visit <a href="http://glass.trex.com">glass.trex.com</a>	Horizontal	6' Glass Railing Kit	XXA06HGLRK	WT BK

Dimensions above are nominals. See below for actuals and metrics.  
 6' x 36": 72 in x 36 in (182 cm x 914 mm)    8' x 36": 96 in x 36 in (243 cm x 914 mm)  
 6' x 42": 72 in x 42 in (182 cm x 106 cm)    8' x 42": 96 in x 42 in (243 cm x 106 cm)  
 6': 72 in (182 cm)

XX=COLOR PREFIX    XXXX=COLOR COMBINATION  
 WT Classic White    BZ Bronze    BK Charcoal Black    PL Platinum

# TREX SIGNATURE RAILING

## 4 INFILL PANEL

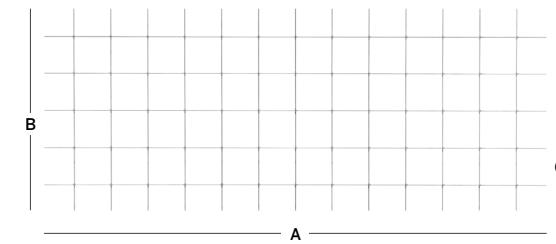

COMPONENT	ORIENTATION	DIMENSIONS	ITEM #	COLORS
<b>Mesh Panel</b> Includes 316L stainless steel mesh panel.  For use with Trex Signature Mesh Rail Kit.	Horizontal	6' x 36" Mesh Panel	SSMESH0636HZ	SS
		8' x 36" Mesh Panel	SSMESH0836HZ	
		8' x 42" Mesh Panel	SSMESH0842HZ	
	Stair	Universal 316L Mesh Panel	SSMESHUNIVST	
<b>Glass Panel</b> For use with Trex Signature Glass Rail Kit.	Horizontal	for 36" Rail Height	To source your infill panel, visit <a href="http://glass.trex.com">glass.trex.com</a>	
		for 42" Rail Height		
	Stair	for 36" Rail Height		
		for 42" Rail Height		
		Universal 316L Mesh Panel		



PANEL	A (WIDTH)	B (HEIGHT)	C (CROSS-HATCHING)
6' x 36" Horizontal	64"	32.375"	4"
8' x 36" Horizontal	88"	32.375"	
8' x 42" Horizontal	88"	38.375"	
8' x 42" Stair	108.1875"	36.1875"	

Dimensions above are nominals. See below for actuals and metrics.  
 6' x 36": 64 in x 32.375 in (162 cm x 822 mm)    8' x 42": 88 in x 38.375 in (223 cm x 974 cm)  
 8' x 36": 88 in x 32.375 in (223 cm x 822 cm)    Universal 316: 108.1875 in x 36.1875 in (274 cm x 919 mm)

## ACCESSORIES







COMPONENT	DESCRIPTION	ITEM #	COLORS
<b>IRC Aluminum Mounting Plate &amp; Hardware</b> Includes hardware for 2.5" IRC Trex Signature surface mount posts, 1 aluminum backer plate, 4 HG carriage bolts and 4 HG washers and nuts.	 Surface mount post attachment hardware for wood substructure used to achieve IRC-compliant post attachment.	ALPOSTHWDECK	n/a
<b>Concrete Post Mount Kit</b> Includes (4) 3/8" x 3-3/4" (9.5 mm x 76 mm) expansion anchors, 4 flat washers and 4 hex nuts.	 Surface mount post attachment hardware for concrete used to achieve IRC-compliant post attachment.	ALPOSTHWCONC	n/a

XX=COLOR PREFIX  
 WT Classic White    BZ Bronze    BK Charcoal Black    SS Stainless Steel



# TREX SIGNATURE RAILING

## ACCESSORIES (continued)











COMPONENT	DESCRIPTION	ORIENTATION	ITEM #	COLORS
<b>Fascia Mount Bracket - Wood Framing</b> Includes fascia mount bracket. 	Required for the mounting of Trex Signature joist mount post; for fascia mount applications only.	n/a	XXFMNTWOOD	WT BZ BK
<b>Fascia Mount Post - Corner Kit</b> Includes fascia mount bracket and hardware for 2.5" Trex Signature joist mount post. 	Mounting bracket and hardware for joist mount double-corner posts, used for fascia-mounted Trex Signature railing installations. Fascia mount brackets also required. For wood frames only.	n/a	XXCORNERFMNTWOOD	WT BZ BK
<b>Rod Rail Vertical Cut Kits</b> Includes end verticals, anti-rattle straws and mounting hardware. 	Use as an accessory for cut rod rail kit sections. Brackets not included.	Horizontal	XX36RODHVERTK	BK PL
			XX42RODHVERTK	
		Stair	XX36RODSVERTK	
			XX42RODSVERTK	
<b>Mesh Rail Vertical Cut Kits</b> Includes vertical supports, vertical gaskets, L-brackets and hardware. 	Use as an accessory for cut mesh rail kit sections. Includes 1 bracket pack.	Horizontal	XX36MSHHVERTK	BZ BK
			XX42MSHHVERTK	
		Stair	XX36MSHSVVERTK	
			XX42MSHSVVERTK	
<b>Trex Signature Bracket Templates</b> Includes 1 reusable template. 	Simplify bracket placement when installing Trex Signature aluminum railing with 4" x 4" Trex composite post sleeves.	Horizontal	SIGTEMP4X4SLEEVE	n/a
			Simplify bracket placement when installing Trex Signature aluminum posts.	
<b>Cocktail Rail Bracket</b> Includes 10 brackets and 40 color-matched screws. 	Mounting hardware to attach a deck board or 2" x 4" cocktail rail to the top rail of Trex Signature rail kits. Only Trex Transcend and Select deck boards can be used. Not compatible with Signature glass.	n/a	XXCTBKTAL10PK	WT BZ BK

XX=COLOR PREFIX

WT Classic White BZ Bronze BK Charcoal Black PL Platinum

# TREX SIGNATURE RAILING

## ACCESSORIES (continued)

COMPONENT	DESCRIPTION	ORIENTATION	ITEM #	COLORS
<b>Tabless Fixed Bracket</b> Includes 2 top rail brackets with covers, 2 bottom rail brackets with covers, 1 fastener pack and (2) 3M VHB adhesive tabs. 	Brackets with tabs removed to work with assembled panels, glass railing and mesh railing.	Horizontal	XXFHBKTALPNL	WT BZ BK
<b>Swivel Bracket</b> Includes 2 swivel brackets: 1 top and 1 bottom, 2 fastener covers and 1 fastener pack. 	Use for angled applications to achieve up to a 45° angle off the post.	Horizontal	XXSWHBKTAL	WT BZ BK
		Stair	XXSWSBKTAL	
<b>Compound Swivel Bracket</b> Includes 2 compound swivel brackets: 1 top and 1 bottom, 2 fastener covers and 1 fastener pack. 	Use for applications where maximum bracket flexibility is required, such as flared stair railing. Use in place of fixed stair brackets.	Stair	XXCPDSWBKTAL	WT BZ BK
<b>Crossover Bracket</b> Includes crossover bracket, cover and mounting hardware. 	Use to create continuously graspable top rail on horizontal sections. Bracket is included on horizontal crossover posts (see page 48).	Horizontal	XX25FHCBKAL	WT BZ BK
<b>90° Crossover Bracket</b> Includes crossover bracket, cover and mounting hardware. 	Use to create continuously graspable top horizontal rails along a 90° turn in the railing.	Horizontal	XX90FHCBKAL	WT BZ BK
<b>Signature Rail End Cap</b> Includes 1 end cap. 	Aluminum end cap designed to cover Signature Railing end when rails are not terminated at the post.	Horizontal	XXXOVERENDCAP	WT BZ BK
<b>Swivel Crossover Bracket</b> Includes 1 swivel crossover bracket and 2 post-to-bracket fasteners. 	Use to maintain an uninterrupted top rail down stairs. Internal nut loosens to allow various angles.	Stair	XX25RCSWSCBKAL	WT BZ BK
<b>Aluminum Foot Block</b> Includes 1 foot block, anchor and fastener. 	Use to reinforce the bottom rail. Required for 8' sections.	Horizontal	XXALFTBLK	WT BZ BK
<b>Extended Aluminum Foot Block</b> Includes 1 foot block, anchor and fastener. 	Use for stairs or unique situations when rail heights differ. This cut-to-length accessory will provide extra reach and support to the rail section.	n/a	XXAL08FTBLK	WT BZ BK
<b>Touch-up Pen</b> Includes 1 touch-up pen. 	If you scratch a Trex Signature aluminum rail, use these touch-up pens to make the issue disappear.	n/a	XXTOUCHUPPEN	WT BZ BK

XX=COLOR PREFIX

WT Classic White BZ Bronze BK Charcoal Black



# TREX TRANSCEND RAILING

## 3 RAIL KITS

COMPONENT	ORIENTATION	DIMENSIONS	ITEM #	COLORS
<b>Rail &amp; Square Composite Baluster Kit</b> Includes Crown top rail, Universal top/bottom rail, square composite balusters, baluster spacers, adjustable foot block and mounting hardware.  Color option indicates rails and balusters.	Horizontal	6' x 36" Rail & Baluster Kit	XX0636HRK	WT BK VL
		8' x 36" Rail & Baluster Kit	XX0836HRK	
		6' x 42" Rail & Baluster Kit	XX0642HRK	
		8' x 42" Rail & Baluster Kit	XX0842HRK	
	Stair	6' x 36" Rail & Baluster Kit	WT0636SRK	WT
		8' x 36" Rail & Baluster Kit	XX0836SRK	WT BK VL
		8' x 42" Rail & Baluster Kit	XX0842SRK	
	<b>Rail &amp; Round Aluminum Baluster Kit</b> Includes Crown top rail, Universal top/bottom rail, round aluminum balusters, baluster spacers, adjustable foot block and mounting hardware.  Color option indicates rails. Round aluminum balusters come in Charcoal Black.	Horizontal	6' x 36" Rail & Baluster Kit	XXRD0636HRK
8' x 36" Rail & Baluster Kit			XXRD0836HRK	
6' x 42" Rail & Baluster Kit			XXRD0642HRK	
8' x 42" Rail & Baluster Kit			XXRD0842HRK	
Stair		8' x 36" Rail & Baluster Kit	XXRD0836SRK	
		8' x 42" Rail & Baluster Kit	XXRD0842SRK	
<b>Cocktail Rail &amp; Round Aluminum Baluster Kit</b> Includes 2 Universal top/bottom rails, round aluminum balusters, baluster spacers, adjustable foot block and mounting hardware.  Color option indicates rails. Round aluminum balusters come in Charcoal Black.  Only Trex Transcend and Select deck boards can be used for cocktail rail application.	Horizontal	6' x 36" Cocktail Rail & Baluster Kit	WTRD0636HRKCKTL	WT
		8' x 36" Cocktail Rail & Baluster Kit	WTRD0836HRKCKTL	
	Stair	8' x 36" Cocktail Rail & Baluster Kit	WTRD0836SRKCKTL	

Dimensions above are nominals. See below for actuals and metrics.

6' x 36": 67.5 in x 36 in (171 cm x 914 mm)    8' x 36": 91.5 in x 36 in (232 cm x 914 mm)  
 6' x 42": 67.5 in x 42 in (171 cm x 106 cm)    8' x 42": 91.5 in x 42 in (232 cm x 106 cm)

# TREX TRANSCEND RAILING

## 3a TOP RAILS

COMPONENT	DIMENSIONS	ITEM #	COLORS
<b>Crown Top Rail</b> Includes 1 Crown top rail.	6' Crown Top Rail	XXCROWNTR06	WT BK GP RS TH VL
	8' Crown Top Rail	XXCROWNTR08	
<b>Universal Top/Bottom Rail</b> Includes 1 Universal top/bottom rail.  For use when installing a cocktail rail application.	6' Universal Top Rail	XXUNIVTBR06	WT BK GP RS TH VL
	8' Universal Top Rail	XXUNIVTBR08	

## 3b BOTTOM RAILS

COMPONENT	DIMENSIONS	ITEM #	COLORS
<b>Universal Top/Bottom Rail</b> Includes 1 Universal top/bottom rail.	6' Universal Bottom Rail	XXUNIVTBR06	WT BK GP RS TH VL
	8' Universal Bottom Rail	XXUNIVTBR08	

Dimensions above are nominals. See below for actuals and metrics.

6': 67.5 in (171 cm)  
 8': 91.5 in (232 cm)



# TREX TRANSCEND RAILING

## 4 INFILLS

COMPONENT	ORIENTATION	DIMENSIONS	ITEM #	COLORS
<b>Square Composite Balusters</b> Includes 16 square composite balusters.	n/a	Balusters for 36" Rail Height <i>16 pack</i>	XX020230SBK	WT BK GP RS TH VL
	n/a	Balusters for 42" Rail Height <i>16 pack</i>	XX020236SBK	
<b>Round Aluminum Balusters</b> Includes 20 round aluminum balusters.	n/a	Balusters for 36" Rail Height <i>20 pack</i>	XXTA30RBK	WT BZ BK
	n/a	Balusters for 42" Rail Height <i>20 pack</i>	XXTA36RBK	
<b>Glass Panel</b> For use with Trex Transcend Glass Panel Infill Kit.	Horizontal	for 36" Rail Height	To source your infill panel, visit <a href="http://glass.trex.com">glass.trex.com</a>	
		for 42" Rail Height		

Dimensions above are nominals. See below for actuals and metrics.  
 Composite 36": 1.418 in x 1.418 in x 30.375 in (36 mm x 36 mm x 771 mm)  
 Composite 42": 1.418 in x 1.418 in x 36.375 in (36 mm x 36 mm x 923 mm)  
 Aluminum 36": .75 in x 30.25 in (19 mm x 768 mm)  
 Aluminum 42": .75 in x 36.25 in (19 mm x 920 mm)

### HOW MANY BALUSTERS DO YOU NEED TO COMPLETE A RAILING SECTION?

BALUSTER TYPE	6' SECTION	8' SECTION
Square composite Horizontal	13	18
Square composite Stair	11	15
Round aluminum Horizontal	15	20
Round aluminum Stair	12	16

### APPROXIMATE LENGTH OF BALUSTER BY APPLICATION.

	SIGNATURE		TRANSCEND		SELECT	
	36"	42"	36"	42"	36"	42"
Round Aluminum	33.485	39.485	30.250	36.250	32.000	38.000
Round Pinned Aluminum	31.406	37.406	-	-	-	-
Square Aluminum	33.485	39.485	-	-	-	-
Square Pinned Aluminum	31.406	37.406	-	-	-	-
Square Composite	-	-	30.375	36.375	-	-

XX=COLOR PREFIX

Composite: WT Classic White BK Charcoal Black GP Gravel Path RS Rope Swing TH Tree House VL Vintage Lantern  
 Aluminum: WT Classic White BZ Bronze BK Charcoal Black

# TREX TRANSCEND RAILING

## 5 ACCESSORY INFILL KITS

COMPONENT	ORIENTATION	DIMENSIONS	ITEM #	COLORS
<b>Square Composite Baluster Infill Kit</b> Includes 2 baluster spacers, adjustable foot block and mounting hardware.	Horizontal	6' Accessory Infill Kit	XXSQHIK06	WT BK GP RS TH VL
		8' Accessory Infill Kit	XXSQHIK08	
	Stair	6' Accessory Infill Kit	XXSQSIK06	
		8' Accessory Infill Kit	XXSQSIK08	
<b>Round Aluminum Baluster Infill Kit</b> Includes 2 baluster spacers, adjustable foot block and mounting hardware.	Horizontal	6' Accessory Infill Kit	XXRDHIK06	WT BK GP RS TH VL
		8' Accessory Infill Kit	XXRDHIK08	
	Stair	6' Accessory Infill Kit	XXRDSIK06	
		8' Accessory Infill Kit	XXRDSIK08	
<b>Glass Panel Infill Kit</b> Includes panel support moldings, adjustable foot block and mounting hardware.	Horizontal	6' Accessory Infill Kit	XXGLIK06	WT BK GP RS TH VL

Dimensions above are nominals. See below for actuals and metrics.  
 6': 67.5 in (171 cm)  
 8': 91.5 in (232 cm)









XX=COLOR PREFIX

WT Classic White BK Charcoal Black GP Gravel Path RS Rope Swing TH Tree House VL Vintage Lantern



## TREX TRANSCEND RAILING

### ACCESSORIES

COMPONENT	DESCRIPTION	ORIENTATION	ITEM #	COLORS
<b>Trex Transcend Bracket Templates</b> Includes 1 reusable template. 	Reusable template to simplify bracket placement when installing Trex Transcend Railing with 4" x 4" Trex Composite Post Sleeves.	Horizontal	TSCTEMP4X4SLEEVE	n/a
<b>Foot Block</b> Includes 1 adjustable foot block. 	Use to reinforce the rail; required for every Trex composite rail section.	n/a	XXFTBLKPC	WT BK GP RS TH VL
<b>Mounting Hardware for Cut Rails</b> Includes 2 Crown top rail gaskets, 4 Universal top/bottom rail gaskets, 4 RSB rail brackets, 8 rail-to-bracket fasteners and 8 rail-to-post fasteners. 	The perfect solution for any installation that requires making two railing sections from one kit.	Horizontal	XXHZACCYKIT	WT BK GP RS TH VL
		Stair	XXSTACCYKIT	
<b>Transcend RSB Bracket Pack</b> Includes RSB rail brackets, rail-to-bracket fasteners and rail-to-post fasteners. 	Use this with mounting hardware kit without the gaskets.	Horizontal	TSHBRACKET	n/a
		Stair	TSSBRACKET	
<b>0° Rail Gasket Pack</b> Includes 2 Crown top rail gaskets and 4 Universal top/bottom rail gaskets. 	Gasket pack for Trex Transcend railing installed at a 0° angle off the post. Hardware not included.	Horizontal	XX00HGASK	WT BK GP RS TH VL
		Stair	XX00SGASK	
<b>22.5° Rail Gasket Pack</b> Includes 2 Crown top rail gaskets and 4 Universal top/bottom rail gaskets. 	Gasket pack for Trex Transcend railing installed at a 22.5° angle off the post. Hardware not included.	Horizontal	XX22HGASK	WT BK GP RS TH VL
<b>45° Birdsmouth Gasket Pack</b> Includes (4) 45° adapters for RSB Rail Brackets, 2 Crown top rail gaskets and 4 Universal top/bottom rail gaskets. 	For 4" x 4" post. Bracket adapter pack for Trex Transcend railing installed at a 45° angle off the post. Hardware not included.	Horizontal	XX45RSBADAPK	WT BK GP RS TH VL
<b>45° Gasket Pack</b> Includes 2 Crown top rail gaskets and 4 Universal top/bottom rail gaskets. 	For 6" x 6" post. Bracket adapter pack for Trex Transcend railing installed at a 45° angle off the post. Hardware not included.	Horizontal	WT45HGASK	WT

XX=COLOR PREFIX

WT Classic White BK Charcoal Black GP Gravel Path RS Rope Swing TH Tree House VL Vintage Lantern

## TREX SELECT RAILING

### 3 RAIL KITS

COMPONENT	ORIENTATION	DIMENSIONS	ITEM #	COLORS
<b>Rail &amp; Round Aluminum Baluster Kit</b> Includes top rail, bottom rail, round aluminum balusters, adjustable foot block and hardware pack.  Color option indicates Classic White rails. Round aluminum balusters come in Charcoal Black. 	Horizontal	6' x 36" Rail & Baluster Kit	WTRD0636HSELK	WT
		8' x 36" Rail & Baluster Kit	WTRD0836HSELK	
		6' x 42" Rail & Baluster Kit	WTRD0642HSELK	
		8' x 42" Rail & Baluster Kit	WTRD0842HSELK	
	Stair	6' x 36" Rail & Baluster Kit	WTRD0636SSELK	
		8' x 36" Rail & Baluster Kit	WTRD0836SSELK	
		8' x 42" Rail & Baluster Kit	WTRD0842SSELK	

Dimensions above are nominals. See below for actuals and metrics.

6' x 36": 67.5 in x 36 in (171 cm x 914 mm)    8' x 36": 91.5 in x 36 in (232 cm x 914 mm)  
 6' x 42": 67.5 in x 42 in (171 cm x 106 cm)    8' x 42": 91.5 in x 42 in (232 cm x 106 cm)

### ACCESSORIES

COMPONENT	DESCRIPTION	ORIENTATION	ITEM #	COLORS
<b>Mounting Hardware for Cut Rails</b> Includes 8 bracket-to-post fasteners, 12 bracket-to-rail fasteners and 4 railing brackets. 	Use to mount 1 section of Select rail. The perfect solution for any installation that requires making two railing sections from one kit.	Horizontal	BKENHZBKT	BK
		Stair	BKENSTBKT	
<b>8' Aluminum Rail Stiffener</b> Includes 1 aluminum rail stiffener. 	Use to strengthen and stabilize the 8' rail. IRC-compliant applications only. Compatible with top rail only.	n/a	SELALRAILSTIFFENER	n/a
<b>Foot Block</b> Includes 1 adjustable foot block. 	Use to reinforce the rail; required for every Trex composite rail section.	n/a	XXFTBLKPC	WT BK GP RS TH VL

XX=COLOR PREFIX

WT Classic White BK Charcoal Black GP Gravel Path RS Rope Swing TH Tree House VL Vintage Lantern



RAILING ENHANCEMENTS

OUTDOOR LIGHTING

COMPONENT	DIMENSIONS	ITEM #	COLORS
<p><b>Flat Post Cap Light</b> Includes LED Post Cap Light and 5.5' Male LightHub® Lead. Use with Trex 4" x 4" composite post sleeve.</p> 	<p>4" x 4" LED Composite Post Cap Light <i>Actual internal dimensions: 4.55 in x 4.55 in (115 mm x 115 mm)</i></p>	XXSQLEDCAP4X4C	WT BK GP RS TH VL
<p><b>Aluminum Post Cap Light</b> Includes LED Aluminum Post Cap Light and 5.5' Male LightHub Lead. Use with Trex 2.5" x 2.5" Signature Aluminum Posts.</p> 	<p>2.5" x 2.5" LED Aluminum Post Cap Light <i>Actual internal dimensions: 2.6 in x 2.6 in (66 mm x 66 mm)</i></p>	XXALCAPLED25	WT BZ BK
<p><b>Aluminum Deck Rail Light</b> Includes LED Deck Rail Light and 5.5' Male LightHub Lead.</p> 	<p>LED Deck Rail Light <i>Actual dimensions: 2.75 in (69 mm)</i></p>	XXLAMPLEDC	WT BZ BK
<p><b>Aluminum Wedge Deck Rail Light</b> Includes LED Wedge Deck Rail Light and 5.5' Male LightHub Lead.</p> 	<p>LED Deck Rail Light <i>Actual dimensions: 1.875 in x 3 in (47 mm x 76 mm)</i></p>	XXALPOSTLAMPLED	WT BZ BK
<p><b>Aluminum Stair Riser Light</b> Includes 4 LED Stair Riser Lights and 5.5' Male LightHub Lead.</p> 	<p>Stair Riser Lights <i>Actual dimensions: 1.25 in (31 mm)</i></p>	XXRISERLED4PKC	WT BZ BK
<p><b>Recessed Deck Light</b> Includes 4 LED Recessed Lights and 5.5' Male LightHub Lead.</p> 	<p>Recessed Deck Lights <i>Actual dimensions: 1 in (25 mm)</i></p>	RECESSLED4PKC	n/a

XX=COLOR PREFIX

Composite: WT Classic White BK Charcoal Black GP Gravel Path RS Rope Swing TH Tree House VL Vintage Lantern  
Aluminum: WT Classic White BZ Bronze BK Charcoal Black

RAILING ENHANCEMENTS

OUTDOOR LIGHTING ACCESSORIES

COMPONENT	DIMENSIONS	ITEM #	COLORS
<p><b>Transformer with Timer</b> Includes transformer with photo-activated timer and 20' LightHub wire extension cable.</p> 	<p>8.3A, 100W Dimmable Transformer <i>Output Voltage: 12VDC</i></p>	83DLTRANSFORMERCC	n/a
	<p>2.5A, 30W Transformer <i>Output Voltage: 12VDC</i></p>	25DLTRANSFORMER	
<p><b>Multizone Transformer Adapter</b> Splits the Transformer ports for multi-zone installs.</p> 	n/a	DL5TFSPPLIT1PK	n/a
<p><b>Dimmer</b> Includes single channel with remote.</p> 	n/a	DLDIMMER	n/a
<p><b>Forstner Bit</b> Includes 6 bits.</p> 	<p>Forstner Bit — 6 pack <i>Actual dimensions: 1 in (25 mm)</i></p>	DLBIT6PK	n/a
<p><b>3-Way Splitter</b></p> 	n/a	DL3SPLIT6PK	n/a
<p><b>6-Way Splitter</b></p> 	n/a	DL6SPLIT4PK	n/a
<p><b>Wire Extension Cable</b></p> 	5' (1.52 m) Wire Extension Cable	DL5FTWR4PK	n/a
	10' (3.04 m) Wire Extension Cable	DL10FTWR4PK	
	20' (6.09 m) Wire Extension Cable	DL20FTWR4PK	
	40' (12.19 m) Wire Extension Cable	DL40FTWR2PK	
	60' (18.28 m) Wire Extension Cable	DL60FTWR1PK	
<p><b>20' Transformer Wire</b></p> 	20' (6.09 m) Wire Cable	DL20FTWRTF1PK	n/a
<p><b>Female-to-Female Adapter</b></p> 	n/a	DLFADAP6PK	n/a

XX=COLOR PREFIX

WT Classic White BK Charcoal Black



## RAILING ENHANCEMENTS

### ADA HANDRAIL

COMPONENT	DESCRIPTION	ITEM #	COLORS
<b>Hand Rail</b>	Install to create a continuously graspable 8' rail. <i>Actual dimensions: 1.375 in x 96 in (34 mm x 243 cm)</i>	XXALADARAIL8	WT BZ BK
<b>Wall Return 90°</b>	Termination bracket for ADA installation.	XXALADA90WR2G	WT BZ BK
<b>Wall Mount</b>	Supports the rail as it spans past posts to create a continuously graspable rail.	XXALADAWMNT2G	WT BZ BK
<b>Corner Mount</b>	Mount to the inside corner of a post to create a turn on a landing.	XXALADAICORNER2G	WT BZ BK
<b>Post Return ("Candy Cane")</b>	Allows installations to terminate back into the top and/or bottom post.	XXALADA180CCANE	WT BZ BK
<b>5° Elbow</b>	Use for wheelchair ramps; allows the 180° "Candy Cane" to be installed parallel to the ground. Match the angle of stairs to the angle of this elbow.	XXALADA05ELB	WT BZ BK
<b>31° Elbow</b>	Use with 180° "Candy Cane". Needed to make sure the termination is parallel to the ground. Match the angle of stairs to the angle of this elbow.	XXALADA31ELB	WT BZ BK
<b>34° Elbow</b>	Use with 180° "Candy Cane". Needed to make sure the termination is parallel to the ground. Match the angle of stairs to the angle of this elbow.	XXALADA34ELB	WT BZ BK
<b>36° Elbow</b>	Use with 180° "Candy Cane". Needed to make sure the termination is parallel to the ground. Match the angle of stairs to the angle of this elbow.	XXALADA36ELB	WT BZ BK
<b>90° Inside/Outside Elbow</b>	Use on turns inside stair landings or used in creative ways to create railing terminations.	XXALADA90ELB2G	WT BZ BK
<b>ADA Adjustable Elbow</b>	Use with 180 degree "Candy Cane" to ensure termination is parallel to the ground. Use in other unique ways to create railing terminations.	XXALADAADJELB	WT BZ BK
<b>Straight 4" Internal Connector</b>	Use where two hollow pieces come together. Collar is included to ensure a smooth transition between pieces.	XXALINTCONN	WT BZ BK
<b>Inline Rail Termination Adapter</b>	The inline bracket is used for straight-line terminations such as into a post or a wall.	XXALADAINLINE	WT BZ BK
<b>Rail End Cap</b>	Aluminum end cap used to cover up the hollow handrail at the end of termination.	XXALADACAP	WT BZ BK
<b>Aluminum Collar</b>	Use as needed to ensure all gaps are covered.	XXALADACLR	WT BZ BK

## RAILING ENHANCEMENTS

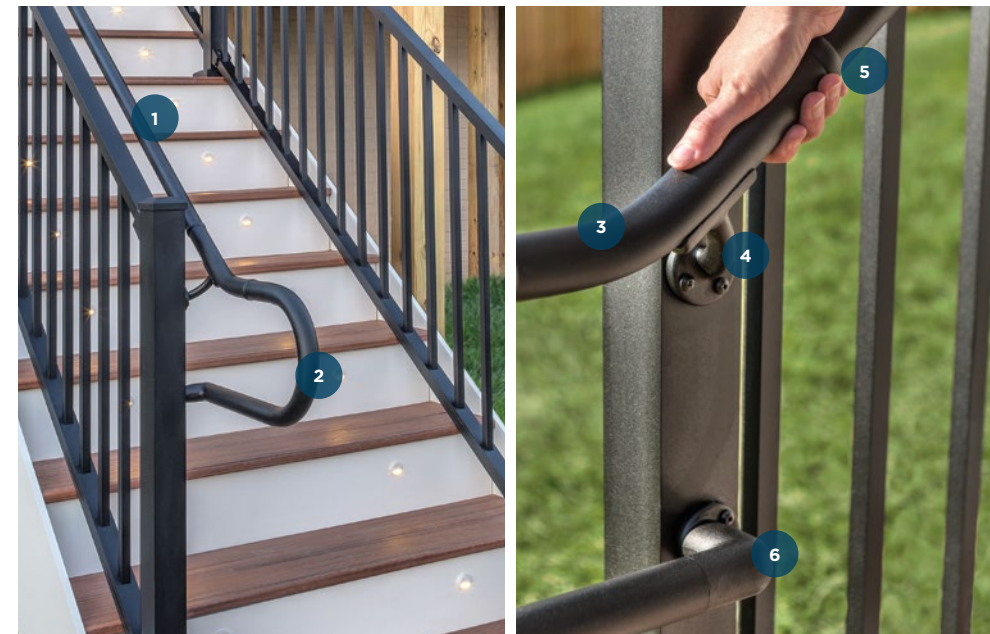

**Our ADA-compliant handrail system uses multiple components to create a continuously graspable handrail.**

- 1 Hand Rail
- 2 Post Return (Candy Cane)
- 3 36° Elbow
- 4 Wall Mount
- 5 Aluminum Collar
- 6 Wall Return 90°

### GATES

COMPONENT	DIMENSIONS	ITEM #	COLORS
<b>Gate Rail Kit - Square Balusters</b> Includes 1 welded gate panel, 2 pre-punched 2" gate posts, (2) 2" gate post caps and 16 aluminum screws.	36" Rail Height, adjustable up to 48" wide opening <i>Actual dimensions: 120 cm x 914 mm</i>	XX36SQADJGATE	WT BZ BK
	42" Rail Height, adjustable up to 48" wide opening <i>Actual dimensions: 120 cm x 106 cm</i>	XX42SQADJGATE	
<b>Gate Rail Kit - Round Balusters</b> Includes 1 welded gate panel, 2 pre-punched 2" gate posts, (2) 2" gate post caps and 16 aluminum screws.	36" Rail Height, adjustable up to 48" wide opening <i>Actual dimensions: 120 cm x 914 mm</i>	XX36RDADJGATE	WT BZ BK
	42" Rail Height, adjustable up to 48" wide opening <i>Actual dimensions: 120 cm x 106 cm</i>	XX42RDADJGATE	
<b>Hardware Pack</b> Includes 2 glass-filled nylon hinges (stainless internals), 1 locking latch with keys, 18 aluminum screws and 10 wood screws.	Hardware Pack	BKGATEHW	BK





## TREX® LIMITED WARRANTY

Trex Company, Inc. (hereinafter "Trex") warrants to the original purchaser ("Purchaser") that, for the period of time set forth in the following sentence, under normal use and service conditions, Trex® product (the "Product") shall be free from material defects in workmanship and materials, and shall not split, splinter, rot or suffer structural damage from termites or fungal decay. The term of such warranty shall be twenty-five (25) years from the date of original purchase for a residential application, and ten (10) years from the date of original purchase for a commercial application. If a defect occurs within the warranty period, Purchaser shall notify Trex in writing and, upon confirmation by an authorized Trex representative of the defect, Trex's sole responsibility shall be, at its option, to either replace the defective Product or refund the portion of the purchase price paid by Purchaser for such defective Product (not including the cost of its initial installation).

For purposes of this warranty, a "residential application" shall refer to an installation of the Product on an individual residence, and a "commercial application" shall refer to any installation of the Product other than on an individual residence.

**Notwithstanding the foregoing, (a), the term of the warranty for the LED lights and housing for Trex DeckLighting™ shall be seven (7) years, the term of the warranty for the LED lights and housing for Trex LandscapeLighting™ shall be five (5) years, the term of the warranty for the dimmer, timer and transformer for both shall be three (3) years, and the term of the warranty for the motion controller for both shall be one (1) year, in each case provided that a Trex transformer is used (with no warranty on any components if a Trex transformer is not used), and any other parts or accessories shall not be warranted; (b) with respect to hardware for the Trex Surroundings® gate (gate frame, hinges and screws), the term of the warranty shall be five (5) years, (c) with respect to Trex Decorative Balusters, the term of the warranty covering the paint coating shall be ten (10) years, and shall be prorated in the following manner: 100% replacement for the first five (5) years; and 50% replacement for the next five (5) years, (d) the term of the warranty for Transcend Product used as outdoor cladding shall be twenty-five (25) years for both a residential application and a commercial application, and (e) this warranty shall not apply to Trex Elevations® steel deck framing, Trex Signature® aluminum railing and TrexTrim™ (which each have separate warranties).**

**TO THE FULLEST EXTENT PERMITTED UNDER THE LAW, THIS WARRANTY SHALL NOT COVER AND TREX SHALL NOT BE RESPONSIBLE FOR COSTS AND EXPENSES INCURRED WITH RESPECT TO THE REMOVAL OF DEFECTIVE PRODUCT OR THE INSTALLATION OF REPLACEMENT MATERIALS, INCLUDING BUT NOT LIMITED TO LABOR AND FREIGHT.**

With respect to a residential application, this warranty may be transferred one (1) time, within the five (5) year period beginning from the date of original purchase by the Purchaser, to a subsequent buyer of the

property upon which the Product was originally installed. With respect to a commercial application, this warranty is freely transferable to subsequent buyers of the property upon which the Product was originally installed.

To make a claim under this limited warranty, Purchaser, or the transferee, shall send to Trex, within the warranty period referred to above, a description of the claimed defect and proof of purchase, to the following address:

Trex Company, Inc.  
Customer Relations  
160 Exeter Drive  
Winchester, VA 22603-8605

Trex does not warrant against and is not responsible for any condition attributable to: (1) improper installation of Product and/or failure to abide by Trex's installation guidelines, including but not limited to improper gapping; (2) use of Product beyond normal use and service conditions, or in an application not recommended by Trex's guidelines and local building codes; (3) movement, distortion, collapse or settling of the ground or the supporting structure on which Product is installed; (4) any act of God (such as flooding, hurricane, earthquake, lightning, etc.), environmental condition (such as air pollution, mold, mildew, etc.), staining from foreign substances (such as dirt, grease, oil, etc.), or normal weathering (defined as exposure to sunlight, weather and atmosphere which will cause any colored surface to gradually fade, chalk, or accumulate dirt or stains); (5) variations or changes in color of Product; (6) improper handling, storage, abuse or neglect of Product by Purchaser, the transferee or third parties; or (7) ordinary wear and tear.

No person or entity is authorized by Trex to make and Trex shall not be bound by any statement or representation as to the quality or performance of Product other than as contained in this warranty. This warranty may not be altered or amended except in a written instrument signed by Trex and Purchaser.

**TO THE FULLEST EXTENT PERMITTED UNDER THE LAW, UNDER NO CIRCUMSTANCES WILL TREX BE LIABLE FOR INCIDENTAL OR CONSEQUENTIAL DAMAGES, WHETHER SUCH DAMAGES ARE SOUGHT IN CONTRACT, IN TORT (INCLUDING BUT NOT LIMITED TO NEGLIGENCE AND STRICT LIABILITY) OR OTHERWISE, AND TREX'S LIABILITY FOR NON-PERSONAL INJURY CLAIMS WITH RESPECT TO DEFECTIVE PRODUCT SHALL IN NO EVENT EXCEED THE REPLACEMENT OF SUCH PRODUCT OR REFUND OF THE PURCHASE PRICE, AS DESCRIBED ABOVE.**

Some States or Provinces do not allow the exclusion or limitation of incidental or consequential damages, so the above limitation or exclusion may not apply to you. This warranty gives you specific legal rights, and you may also have other rights that vary from State to State or Province to Province.

Copyright © 2019 Trex Company, Inc.



## TREX SIGNATURE® RAILING LIMITED WARRANTY

Trex Company, Inc. (hereinafter "Trex") warrants to the original purchaser ("Purchaser") that, under normal use and service conditions, Trex Signature® Railing (the "Product") shall, for a period of twenty-five (25) years from the date of original purchase, be free from material defects in workmanship and materials. If a defect occurs within the warranty period, Purchaser shall notify Trex in writing and, upon confirmation by an authorized Trex representative of the defect, Trex's sole responsibility shall be, at its option, to either replace the defective Product or refund the portion of the purchase price paid by Purchaser for such defective Product (not including the cost of its initial installation).

With respect to installations where the atmosphere is influenced by a body of salt water (or other contaminant conditions), failure to adhere to the cleaning guidelines available at [www.trex.com](http://www.trex.com) will void this warranty with respect to any condition resulting from such failure.

**TO THE FULLEST EXTENT PERMITTED UNDER THE LAW, THIS WARRANTY SHALL NOT COVER AND TREX SHALL NOT BE RESPONSIBLE FOR COSTS AND EXPENSES INCURRED WITH RESPECT TO THE REMOVAL OF DEFECTIVE PRODUCT OR THE INSTALLATION OF REPLACEMENT MATERIALS, INCLUDING BUT NOT LIMITED TO LABOR AND FREIGHT.**

This warranty may be transferred one (1) time, within the five (5) year period beginning from the date of original purchase by the Purchaser, to a subsequent buyer of the property upon which the Product was originally installed.

To make a claim under this limited warranty, Purchaser, or the transferee, shall send to Trex, within the warranty period referred to above, a description of the claimed defect and proof of purchase, to the following address:

Trex Company, Inc.  
Customer Relations  
160 Exeter Drive  
Winchester, VA 22603-8605

Trex does not warrant against and is not responsible for any condition attributable to: (1) improper installation of the Product; (2) use of the Product beyond normal use and service conditions, or in an application not recommended by Trex's guidelines and local building codes; (3) movement, distortion, collapse or settling of the ground or the supporting structure on which the Product is installed; (4) damages attributable to fire, violent storms, earthquake or other Acts of God, accidents, vandalism, or other casualties, impact of objects, or exposure to atmospheric pollutants or conditions other than natural weather processes, (5) improper handling, storage, abuse or neglect of the Product by Purchaser, the transferee or third parties; or (6) ordinary wear and tear.

No person or entity is authorized by Trex to make and Trex shall not be bound by any statement or representation as to the quality or performance of Trex products other than as contained in this warranty. This warranty may not be altered or amended except in a written instrument signed by Trex and Purchaser.

**TO THE FULLEST EXTENT PERMITTED UNDER THE LAW, UNDER NO CIRCUMSTANCES WILL TREX BE LIABLE FOR INCIDENTAL OR CONSEQUENTIAL DAMAGES, WHETHER SUCH DAMAGES ARE SOUGHT IN CONTRACT, IN TORT (INCLUDING BUT NOT LIMITED TO NEGLIGENCE AND STRICT LIABILITY) OR OTHERWISE, AND TREX'S LIABILITY FOR NON-PERSONAL INJURY CLAIMS WITH RESPECT TO DEFECTIVE PRODUCTS SHALL IN NO EVENT EXCEED THE REPLACEMENT OF SUCH PRODUCTS OR REFUND OF THE PURCHASE PRICE, AS DESCRIBED ABOVE.**

Some States or Provinces do not allow the exclusion or limitation of incidental or consequential damages, so the above limitation or exclusion may not apply to you. This warranty gives you specific legal rights, and you may also have other rights that vary from State to State or Province to Province.

Copyright © 2020 Trex Company, Inc.



# Ready to build?

GET STARTED WITH OUR HELPFUL TOOLS



## NEED A TREXPRO® BUILDER?

Find a local, pre-approved contractor at [trex.com/findapro](https://www.trex.com/findapro)



## NEED A TREX DEALER?

Find nearby retailers at [trex.com/locations](https://www.trex.com/locations)



## NEED SPARE OR REPLACEMENT PARTS?

Order them at [trex.com/shop](https://www.trex.com/shop)



## NEED INSTALLATION INSTRUCTIONS?

Download them at [trex.com/literature](https://www.trex.com/literature)



## NEED TO VISUALIZE IT?

Download the Trex AR Visualizer App.



## WANT TO SEE IT IN 3D?

Discover the possibilities at [trex.com/deckdesigner](https://www.trex.com/deckdesigner)



## NEED ANSWERS OR GUIDANCE?

Call our Customer Experience Center at **1-800-BUY-TREX**



## Universal Fastener Installation Tool

Install a screw-free deck more easily and with more accuracy, all in half the time. Now available at [trex.com/shop](https://www.trex.com/shop)



## Share your build

For a chance to be featured in our Instagram feed, share your photos with **#trexrailing** and tag **@TrexCompany**





posts: Signature in BK  
rail kit: Signature Mesh in BK  
infill: Mesh panel in SS



Engineering What's Next  
in Outdoor Living®

DECKING | RAILING | LIGHTING | FASCIA  
KITCHENS | FURNITURE | PERGOLA | DRAINAGE

Visit **trex.com**  
or call **1-800-BUY-TREX**

FIND US ON



© 2022 Trex Company, Inc. All rights reserved. Trex®, the Trex logo, Trex Signature®, Trex Transcend®, Trex Select®, Trex® OutdoorLighting™, Trex LightHub® and Trex Pro® are either federally registered trademarks, trademarks or trade dress of Trex Company, Inc., Winchester, Virginia or its licensees.

